



Self-priming horizontal multistage stainless steel pumps suitable for domestic use, also in combination with autoclave tank. Suitable for drinking water or glycol, for water treatment, heating, air conditioning and washing systems.

Construction features

Pump body, mechanical seal housing	stainless steel AISI 304
Motor bracket	aluminum
Impellers, diffusers	stainless steel AISI 304
Mechanical seal	ceramic-graphite-EPDM
Motor shaft	stainless steel AISI 303
Liquid temperature	-15 ÷ +110 °C
Operating pressure	max 7 bar

Motor

	3~ 230/400V - 50Hz
2 poles induction motor	1~ 230V - 50Hz (with thermal protection up to 1.85 kW)
Insulation class	F
Protection degree	IPX4

P 3 S A - 100 / 5 T

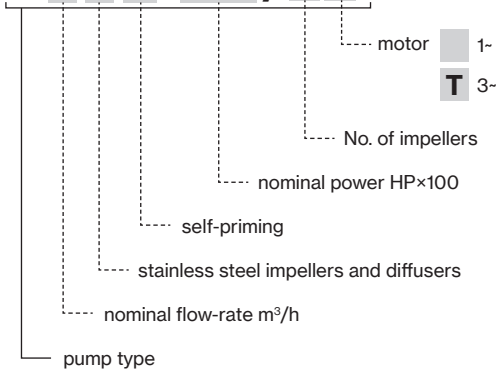

TYPE	LOTS			
	TRUCK		CONTAINER	
	PALLET (cm)	N° pumps	PALLET (cm)	N° pumps
P 3SA-90/4	85×110×160	70	85×110×185	80
P 3SA-100/5	80×120×150	42	80×120×175	49
P 5SA-120/4	80×120×150	42	80×120×175	49
P 5SA-150/5	80×120×150	42	80×120×175	49



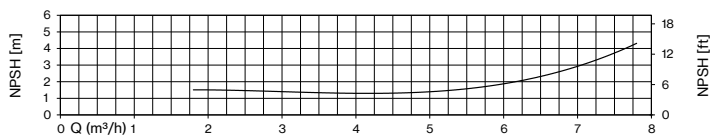
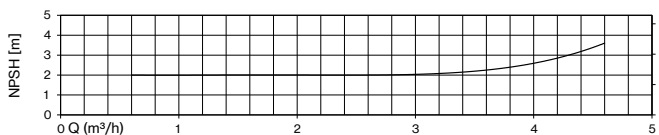
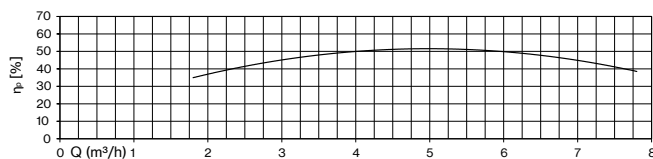
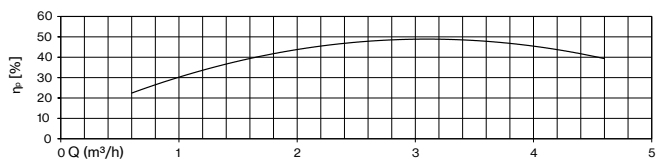
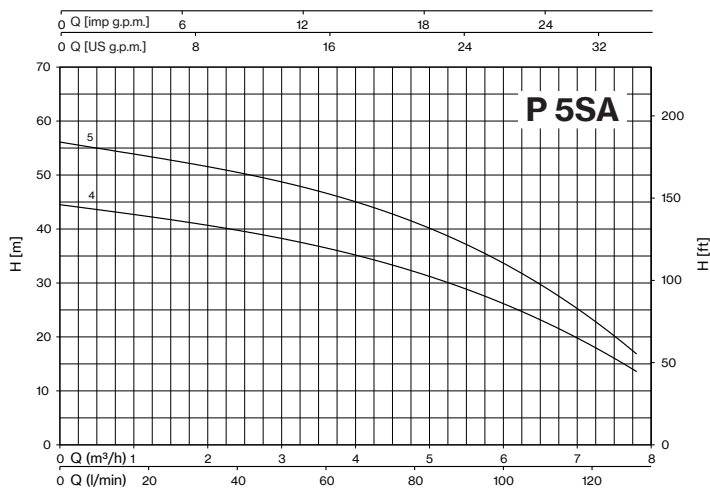
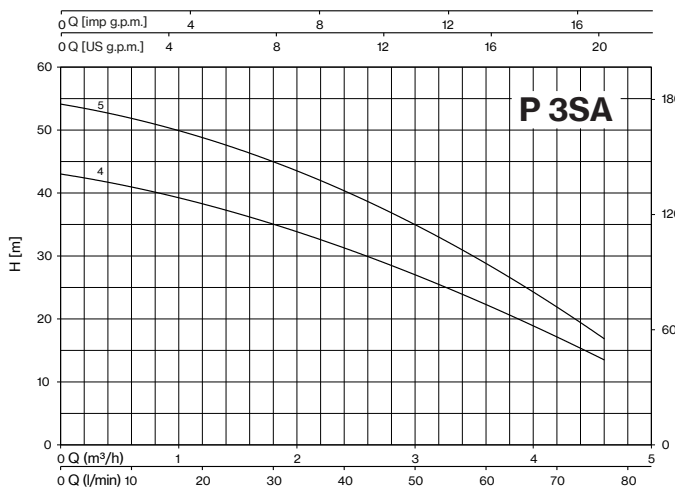

TYPE		P2		P1 (kW)		AMPERE		Q (m³/h - l/min)											
1~	3~	HP	kW	1~	3~	1~ 230V 50 Hz	3~ 400V 50 Hz	0	0,6	1,2	1,8	2,4	3,6	4,6	4,8	6	7	7,8	
								0	10	20	30	40	60	76,7	80	100	116,7	130	
P 3SA-90/4	P 3SA-90/4T	0,9	0,66	0,83	0,8	3,6	1,7	43,0	41,0	38,3	35,0	31,3	22,3	13,5					
P 3SA-100/5	P 3SA-100/5T	1	0,75	0,99	0,92	4,4	1,7	54,0	52,1	48,8	44,9	40,2	29,0	16,8					
P 5SA-120/4	P 5SA-120/4T	1,2	0,9	1,09	1,08	4,9	2,4	44,5			41,0	40,0	36,4	32,8	32,0	26,2	18,5	13,5	
P 5SA-150/5	P 5SA-150/5T	1,5	1,1	1,39	1,31	6,5	2,7	56,0			52,4	50,5	46,4	42,0	41,0	33,8	23,8	16,5	

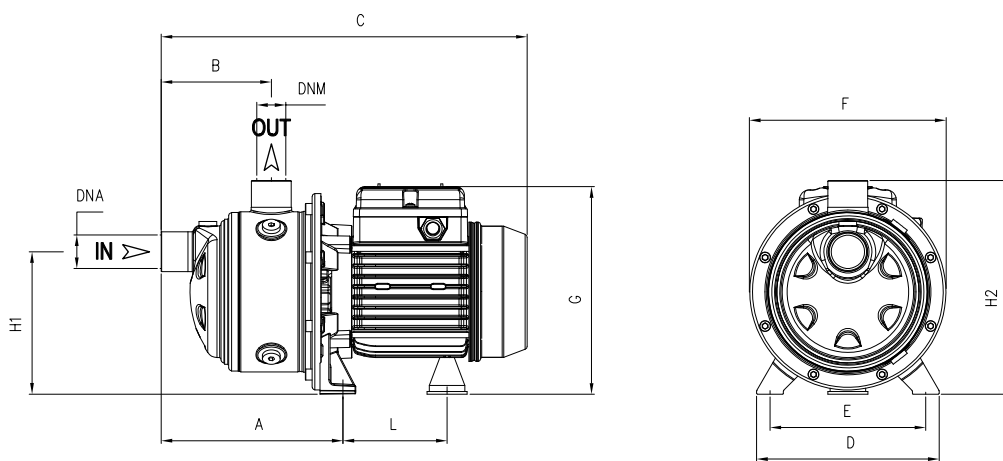

TYPE	DIMENSIONS (mm)											DNA	DNM	Kg
	A	B	C	D	E	F	G	L	H1	H2				
P 3SA-90/4	238,8	175	405	164	140	178	190	93,7	128	192	1" G	1" G	10	
P 3SA-100/5	262,8	199	452	164	140	178	203	104,7	128	192			12,5	
P 5SA-120/4	238,8	175	428	164	140	178	203	104,7	128	192			12,5	
P 5SA-150/5	262,8	199	514	164	140	201	211	128,2	134	198	15,5			